

ULTRASONIC VELOCITY PROFILE MEASUREMENTS IN PIPES AND FLUMES IN A HYDRAULIC LABORATORY

Helmut Knoblauch, Roman Klasinc, Thomas Geisler, Stefanie Breitenstein

Department for Hydraulic Structures and Water Resources Management
Graz University of Technology, Stremayrgasse 10, A-8010 Graz, AUSTRIA, Europe
helmut.knoblauch@TUGraz.at

Keywords: ultrasonic tests, hydraulic model tests, pipes, flume

ABSTRACT

At the Hydraulic Laboratory Graz, Austria, an UVP-Monitor was used to measure flow velocities in pipes and flumes. Moreover the same device was used for measuring the surface level in a flume. Velocity profile measurement was successfully conducted on a physical model of a multi-pipe inverted siphon with three Plexiglas pipes ranging from 62 mm to 246 mm in diameter. Turbulent flow within the pipes was studied under non-intrusive conditions by installing the ultrasonic transducer on the pipe wall. The velocity profiles were obtained by moving the transducer around the pipe to four angles (0° , 45° , 90° , 135°). Measurements in a flume included simultaneous measurement of velocity profiles and fluid surface profiles for wavy flows. These experiments were performed in a horizontal glass channel. The transducer was inserted from above the test section into the medium facing the direction of flow. The transducer axis was placed at various angles to the surface of the water. In the same horizontal channel, water level measurement for wavy flow was performed.

1. TESTS ON PIPE FLOW

1.1 Model stand

The investigation of pipe flow was performed on the test model of an inverted siphon. The model included the inlet and outlet structures, three pressure conduits of various diameters, and adjacent headwater and tailwater areas, as shown in Figure 1.



Figure 1: Test pipes, numbered 1 to 3. Overview (left) and close-up of elbows (right).

The pipes were manufactured from Plexiglas with internal diameters of $d_1=62$, $d_2=172$ and $d_3=246$ mm. The flow conditions were investigated at various discharges to measure velocity profiles at different flows. Table 1 lists the expected flow rates and average velocities for the discharges that were tested. The numbers in the table below are based on the assumed flow distribution among the three pipes.

Pipe 1		Pipe 2		Pipe 3	
Flow [l/s]	Velocity [m/s]	Flow [l/s]	Velocity [m/s]	Flow [l/s]	Velocity [m/s]
1.0 - 1.5	0.35 - 0.51	3.0 - 15.0	0.13 - 0.66	5.0 - 34.0	0.11 - 0.75

Table 1: Expected flow rates and average velocities in the inverted siphon pipes

1.2 Measurement Planes

The flow inside the pipes was investigated by placing the ultrasonic transducer on the pipe wall at an incident angle of 10° from the normal, as shown in Figure 2. Each of the test sections was then divided into four measurement planes, which were evenly distributed over the circumference of the pipe wall.

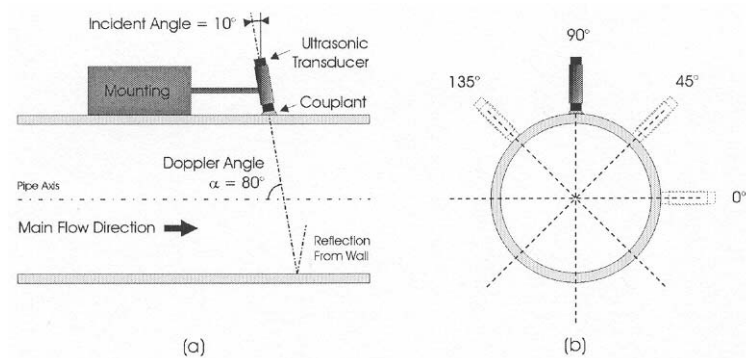

Figure 2: (a) Positioning of the transducer and (b) measurement planes as viewed in the direction of flow

Four measurement planes were used so that the true direction of the velocity vector at one spatial point could be reconstructed. To obtain a suitable amount of profile data, seven test sections on each pipe were investigated. The positions of the test sections along the pipes are shown in Figure 3. The main unit UVP-Monitor (supplied by Met Flow, Lausanne) was operated with a 4-MHz transducer.

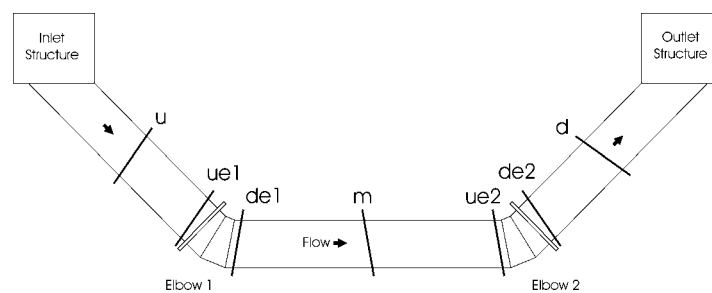

Figure 3: Position of test sections along the pressure pipes of the inverted siphon.

2. RESULTS PIPE FLOW

To give a representation of the obtained results, two measurement sections will be analyzed in more detail. While the first sample deals with measurement at a straight pipe, the second sample covers the measurement that was conducted downstream from a pipe elbow.

2.1 Results straight pipe

The first section to be examined is section **m** on pipe 1 (Figure 3), which is right in the middle of the two elbows. Although the pipe diameter is quite small ($d_1=62$ mm), decent velocity profiles were obtained because of the excellent spatial resolution of the 4-MHz transducer. Figure 4 displays a typical velocity profile measured at this section. The mean time velocities (dots) and the standard deviation (vertical lines) are shown. This plot displays the velocity component along the line of measurement.

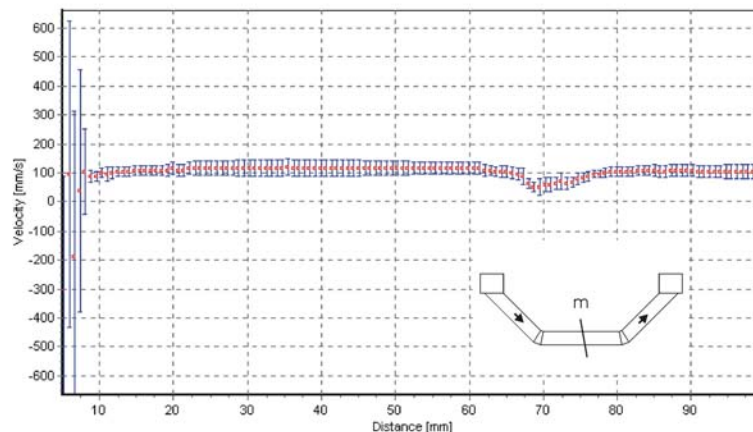

Figure 1: Sample velocity profile obtained at section **m** on pipe 1 showing undistorted turbulent flow.

The profile in Figure 4 indicates the characteristic velocity distribution for turbulent flow. Outside the near wall boundary layer the fluid moves with the full velocity and may be considered to be practically unaffected by the reduction of velocity close to the pipe walls. The velocity gradient is highest at the pipe wall and becomes progressively smaller with increasing distance from the wall.

The decrease of flow velocity in the range of about 70 mm indicates the position of the back wall of the pipe. Beyond this distance, a mirror image of the velocity profile appears. This imaginary profile is caused by ultrasound reflection at the back wall.

2.2 Results bent pipe

This case is expected to happen downstream from the elbows, because the flow becomes separated from the inward bend of the pipe. Hence the second test section to be analyzed is section **de2** on pipe 3 ($d_3=246$ mm). Figure 5 shows a sample profile that was obtained in the vertical measurement plane of this section. Again, the mean time velocities and the standard deviation are shown. In contrast to the previous sample, the flow can neither be considered axially symmetric with respect to the pipe centerline, nor is the highest velocity found in the middle of the stream.

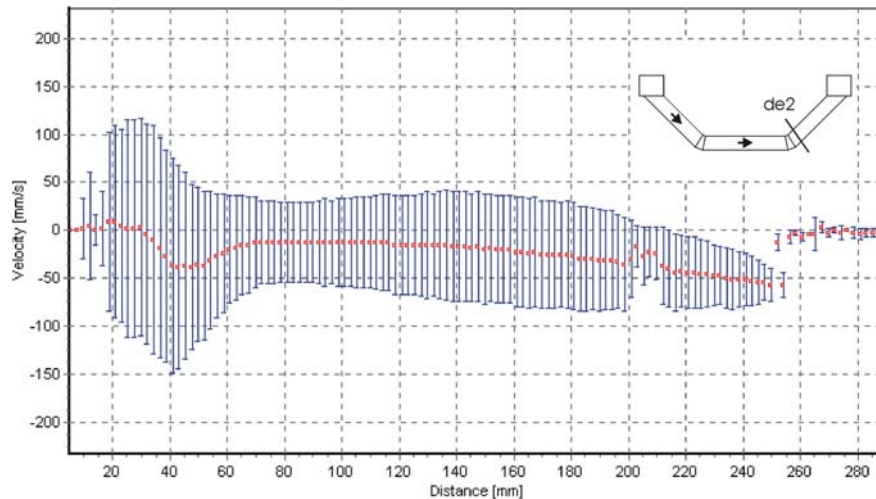

Figure 5: Sample velocity profile obtained at section de 2 on pipe 3

As flow moves through the elbow, it accelerates around the outside of the bend and slows down near the inside of the bend. The profile is distorted with a high velocity zone occurring near the outside of the bend, as shown in Figure 6.

The Doppler angle α varies along the line of measurement due to the converging geometry of the streamlines. In the middle of the stream, flow particles typically travel perpendicular to the measurement line and fail to generate significant frequency shifts. During measurement, however, the flow direction varied so as to generate either a positive or a negative frequency shift, as indicated by the standard deviation in Figure 5.

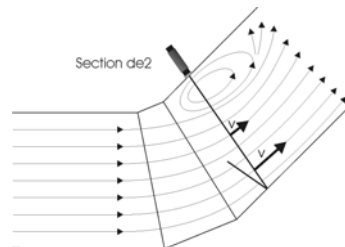

Figure 6: Flow pattern at the elbow showing strong eddies at the inward bend

The velocity is found to be affected by the elbow located upstream from the test section. Flow leaving the elbow is distorted and returns to an undistorted velocity profile after a certain pipe length (6 to 10 times the pipe diameter d). If the test section is located within that zone, the computation of the flow rate is likely to be incorrect.

3. STUDY OF OPEN CHANNEL FLOW

3.1 Test stand

The experiments were performed in a horizontal channel about 10 m long, 30 cm wide, and 80 cm high. The bottom of the channel was made from steel, while the sides were manufactured from glass. Water from the overhead reservoir of the laboratory entered the channel through the pipe system. The inflow was adjusted by a control valve, while the depth of the water was varied using a slide gate at the downstream end of the channel.

3.2 Measurement of Velocity Profiles

Our structure produced waves with a small amplitude at the downstream end of the channel where the test section was positioned. The transducer was inserted from above the surface of the water facing the direction of flow, as shown in Figure 7. The axis of the transducer was placed at two different angles to the surface to test the effect of angle variation. In order to validate the obtained velocity profiles, a Höntzsch current meter with a four-vane propeller of 18-mm diameter was used as well. The UVP-Monitor model XW-3-PSi was operated with the same 4-MHz transducer as in the pipe flow experiments.

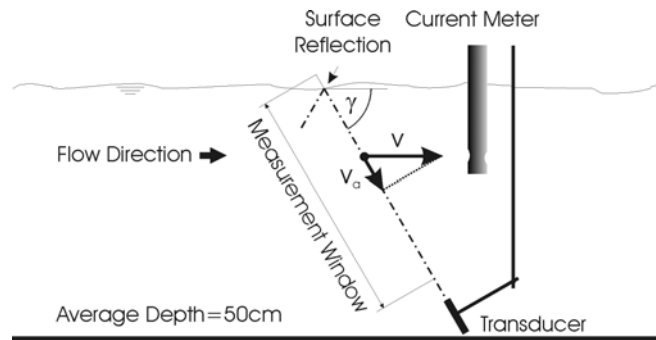

Figure 7: Experimental setup for velocity profile measurements in wavy flow.

The diagram in Figure 8 compares the velocity profiles obtained by the UVP-Monitor with the measurements made by the current meter. The time-averaged velocity profiles were smoothed using a floating average computation. For the most part, the velocity profiles are found to be in good agreement with the samples from the current meter. However, the closer the measurements are to the bottom of the channel, the less the data corresponds, which is caused by disturbances in flow near the ultrasonic transducer.

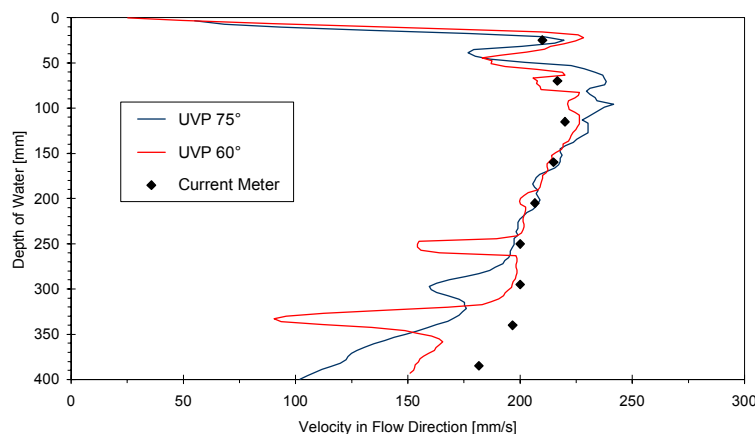

Figure 8: Velocity profiles obtained by UVP-Monitor and current meter.

3.3 Surface Level Measurement

Consideration was given to ways of measuring surface levels with the instrumentation originally designed for velocity profile measurement. For this purpose, separate test runs were conducted to find the most favourable setup for the measurement of surface levels. The largest part of the measurements were made with the 4-MHz transducer, but a 2-MHz transducer was

used as well. The axis of the transducer was placed at three different angles to the surface of the water. The surface level was simultaneously measured by an electrical conductivity method using a pair of parallel wire electrodes (FAFNIR). The results for an angle of 90° to the surface (4 MHz) are displayed in Figure 9.

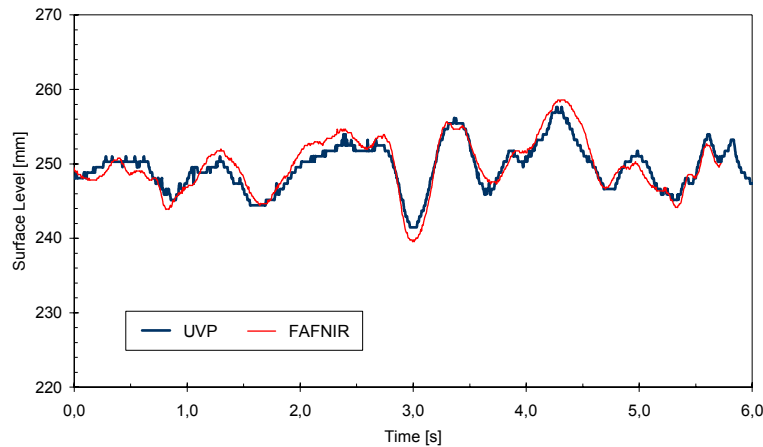

Figure 9: Comparative diagram showing the UVP plot and the output of the FAFNIR probe

4. CONCLUSIONS

Concerning pipe flow the velocity is found to be affected by the elbow located upstream from the test section. Flow leaving the elbow is distorted and returns to an undistorted velocity profile after a certain pipe length (6 to 10 times the pipe diameter d). If the test section is located within that zone, the computation of the flow rate is likely to be incorrect.

Additionally free-surface flow in a glass-walled channel was investigated. The instrument performed measurements of both flow velocity and surface level. The data from the identification process was compared to an electrical conductivity method for the measurement of surface level, showing good agreement if the transducer axis is placed perpendicular to the flow direction. Other measurement angles were tested as well, but the identification of the surface level was found to be less precise.

REFERENCES

- AMERICAN SOCIETY OF NONDESTRUCTIVE TESTING** (1991) *Nondestructive Testing Handbook, Volume 7: Ultrasonic Testing*. Second edition, ASNT, Columbus (USA) www.asnt.org
- MASSEY, B. S.** (1989) *Mechanics of Fluids*. Sixth edition, Chapman & Hall, London
- MET-FLOW** (2000) *User's Guide Model UVP-XW*. Second edition, Met-Flow SA, Lausanne. www.met-flow.com
- NAKAMURA, H., KONDO, M. and KUKITA, Y.** (1996) Simultaneous measurement of liquid velocity and interface profiles of horizontal duct wavy flow by ultrasonic velocity profile meter. *Proceedings of the First International Symposium on Ultrasonic Doppler Methods for Fluid Mechanics and Fluid Engineering (ISUD)*. Paul Scherrer Institute, Villigen (CH)
- PANAMETRICS** (2001) *Ultrasonic Transducers*. Panametrics Inc., NDT Division, Waltham