

# Turbidity current monitoring in a physical model flume using ultrasonic Doppler method

Dr Giovanni De Cesare, Prof. Dr. Anton Schleiss

Laboratory of hydraulic constructions, Swiss Federal Institute of Technology Lausanne, CH-1015  
Lausanne, tel ++41 21 6932385, fax ++41 21 6932264, email : secretariat.lch@epfl.ch

## Summary

*In order to clarify the flow mechanism of river-induced turbidity currents in artificial lakes, physical modelling of turbidity currents was carried out in a laboratory flume. Parallel to the laboratory study, performed at the Laboratory of Hydraulic Constructions at the EPF-Lausanne, field observations have been made in an Alpine reservoir and its main inflow river. The reproduced turbidity currents in the laboratory have been monitored using ultrasound probes functioning with the Doppler Method. Measurements were made in the flume with three different configurations of the ultrasound transducers. The flow in the laboratory flume has been simulated numerically. The results of the laboratory experiments and the numerical calculations were compared in order to check the accuracy of the numerical two-phase flow code. Comparisons were made with vertical and axial velocity profiles. The complete 3D-flow field has been computed and compared with the measured 2D-velocity distribution near the bottom of the flume. The so tested numerical two-phase flow code has then been applied to simulate river-induced turbidity currents directly in an artificial reservoir.*

## 1. Introduction

Sediment deposition in reservoirs causes mainly loss of water storage capacity (Graf 1994, Fan and Morris 1992), the risk of blockage of intakes structures as well as sediment entrainment in hydropower schemes (Boillat et al. 1994, Schleiss et al. 1996, De Cesare 1998). Finally the sediment ends to some extent in the downstream river during flushing (Rambaud et al. 1988). The planning and design of a reservoir require the accurate prediction of sediment transport, erosion and deposition in the reservoir. For existing artificial lakes, more and wider knowledge is still needed to better understand and solve the sedimentation problem, and hence improve reservoir operation.

Turbidity currents are often the governing process in reservoir sedimentation by transporting fine materials over long distances through the impoundment to the vicinity of the dam. They are flows driven by density differences caused by suspended fine solid material. They belong to the family of sediment gravity currents. These are flows of water laden with sediment that move downslope in otherwise still waters like oceans, lakes and reservoirs. Their driving force is gained from the suspended matter, which renders the flowing turbid water heavier than the clear water above. Turbidity currents are encountered in fluvial hydraulics, most prominently if a sediment-laden discharge enters a reservoir, where, during the passage, it may unload or even resuspend granular material.

This paper presents some aspects of physical modelling and numerical simulation of turbidity currents. Special attention is drawn on the measuring technique in the laboratory using ultrasonic Doppler velocimetry.

## 2. Experimental set-up

Figure 1 shows the general schematic view of the flume, two adjacent mixing and storing tanks and the measuring equipment. The flume used in this investigation is 8.4 m long, 1.5 m wide and 65 cm deep. It is made of steel but has a glass wall on one side. On the bottom a 6 m PVC plate is laid which varies a slope from 0 to 6%. Water-sediment mixture is taken place in a separate tank (2 m<sup>3</sup>) with a propeller-type mixer. This tank is connected to an upstream tank by a recirculation pump. The turbid water returns to the mixing tank over a free surface weir, which controls the water level in the upstream tank. A gate with variable width and opening allows the controlled release of the turbidity current into the flume.

Measurements were made in the flume with three different configurations of the UVP transducers. Because the UVP instrument allows only one transducer to be connected at a time, the eight transducers used in the experimental set-up were connected to the UVP via a multiplexing unit.

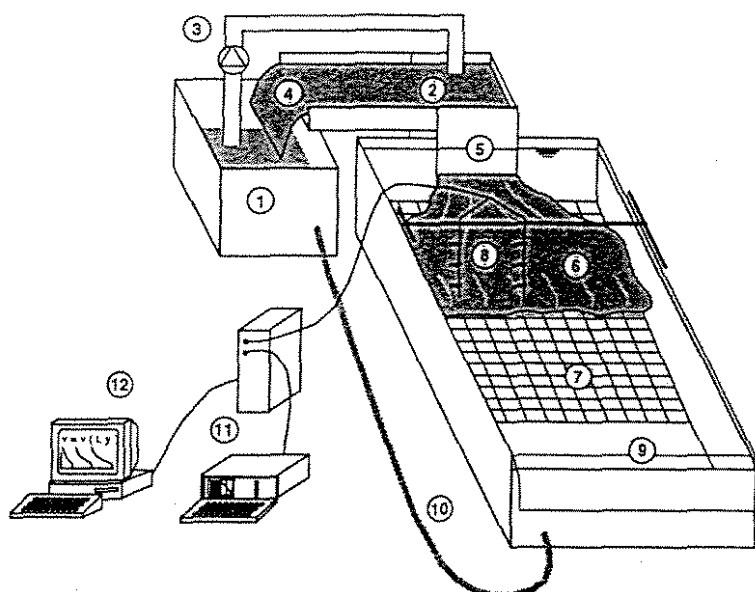
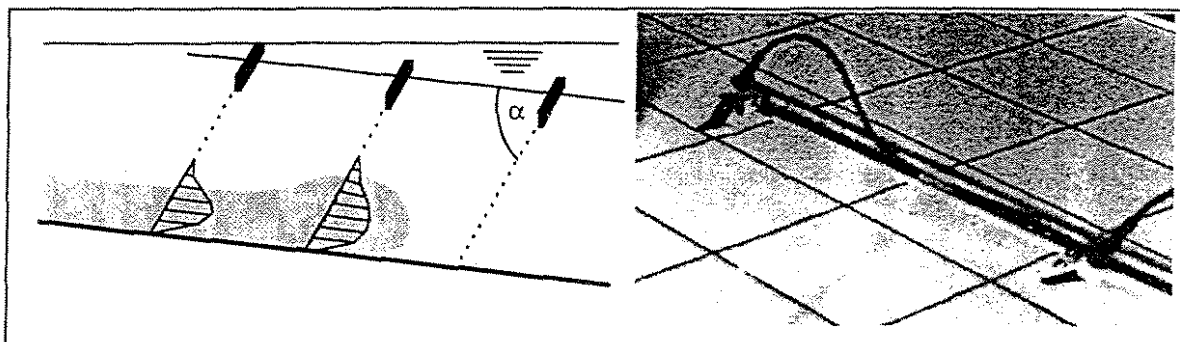

Figure 1:

Schematic drawing of the experimental installation, (1) mixing tank (2) upstream tank (3) recirculation pump (4) free surface weir (5) inflow gate (6) turbidity current (7) experimental flume (8) ultrasonic probes (9) sharp crested weir (10) flexible duct (11) UVP instrument (12) controlling computer

The beam directions and the penetration length were chosen in order to cover the interior of the advancing turbidity current. As the model is symmetric, the profiles were taken on the axis of symmetry and the flow -mapping region was situated on one side of the flume only. The arrangement of the transducers are described as follows:

- Vertical arrangement with 8 transducers looking with an angle of  $60^\circ$  against the main flow. The measurements give the projected vertical velocity profiles over 2 m flow length from the gate, the distance between the transducers was 25 cm.



- Axial disposition with 8 transducers looking straight against the main flow. The measurements give the horizontal velocity profiles over the whole 3 m flow length from the gate, the distance between the transducers was 50 cm. The probes were installed 12 mm above the bottom and were slightly set off laterally in order to reduce interference by reflection of US from different transducers.

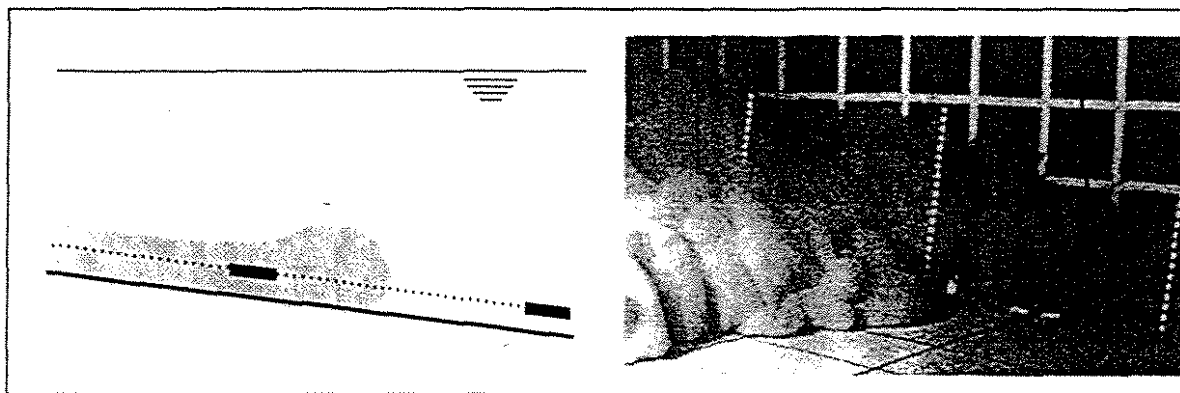

- Square grouping with 4 transducers on each side looking straight at and perpendicular to the main flow in the spreading part just after the inflow gate. The side of the square plane where the flow mapping took place was 62.5 cm long, the distance between transducers was 12.5 cm close to the inflow gate, and 25 cm elsewhere. The transducers were installed with plastic clamps 12 mm above the bottom on an aluminium frame.

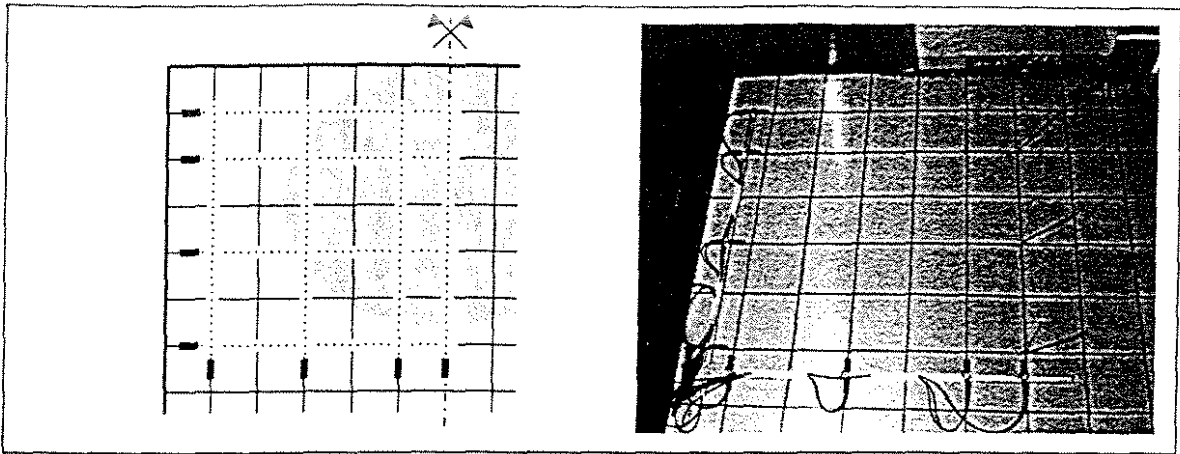

The echo of the flowing turbidity current was strong enough to allow rapid measurements, only 4 successive profiles were taken with each transducer, and the averaged profile is used as velocity profile at one location. The temporal resolution was therefore less than  $\frac{1}{2}$  second per profile. The duration to sweep all transducers was around 3 seconds and the cycle was repeated every 5 seconds, thus giving a quasi-instantaneous velocity information every 5 seconds. The vertical profiles were obtained with 8 measurements per profile, thus doubling cycle time, repetitions were made every 10 seconds.

### 3. Simulated turbidity current

All the experiments were conducted with fine homogenous clay as suspended matter. The density of the sediments is  $\rho_s = 2'740 \text{ kg/m}^3$ . The particle size distribution ranges from  $d_{10} = 0.002 \text{ mm}$  to  $d_{90} = 0.1 \text{ mm}$ , with a mean particle diameter of  $d_{50} = 0.02 \text{ mm}$ . The corresponding settling velocity calculated using Stokes law is  $v_{ss} \approx 0.4 \text{ mm/s}$  for the representative particle size in calm water. In all experiments the clear water from the main reservoir of the hydraulic laboratory was used as the ambient fluid. The water-sediment mixtures were prepared in the mixing tank by adding the dry clay to the clear water. The density of the water-sediment mixture,  $\rho_m$ , varied between  $1'002$  and  $1'005 \text{ kg/m}^3$ , and the mixture was considered to be a Newtonian Fluid.

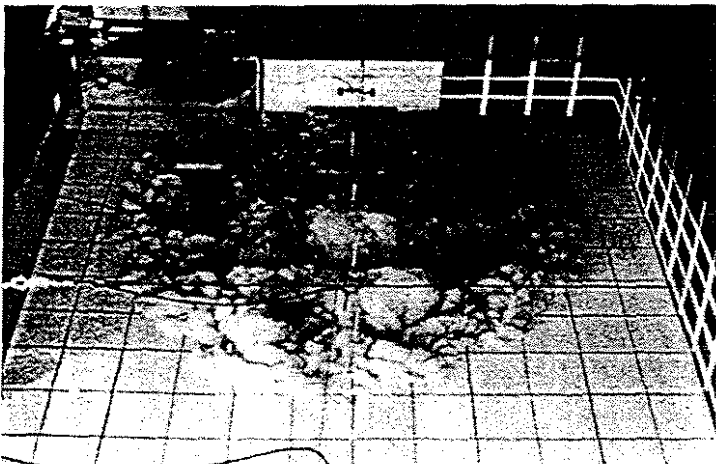

Figure 2:

Photograph of the expanding turbidity current in the experimental flume 25 s after opening of the gate, the current spreads out almost radial, 125mm x 125mm grid on PVC bottom

Figure 2 shows a photograph of the spreading turbidity current 25 seconds following its initial release. After its spreading to the total flume width, the current adjusted itself rapidly to a uniform flow advancing steadily within the tank. When the current reached the downstream end of the flume, the turbid water was evacuated by opening the bottom gate. During the total duration of the experiment the same turbid water flux was fed from the inflow gate.

### 4. Experimental results

The measured velocity profiles were compared a theoretical distribution, the result agrees well as shown in Figure 3. A bottom surface layer region, where the velocity distribution is logarithmic and a jet region, where the velocity is the half Normal (Gaussian) distribution.

Figure 4 shows the velocity distribution in the turbidity current expansion. Both calculated and measured values are plotted on the same graph. The results of the numerical modelling are presented by a surface of equal concentration where the maximum concentration gradient can be found.

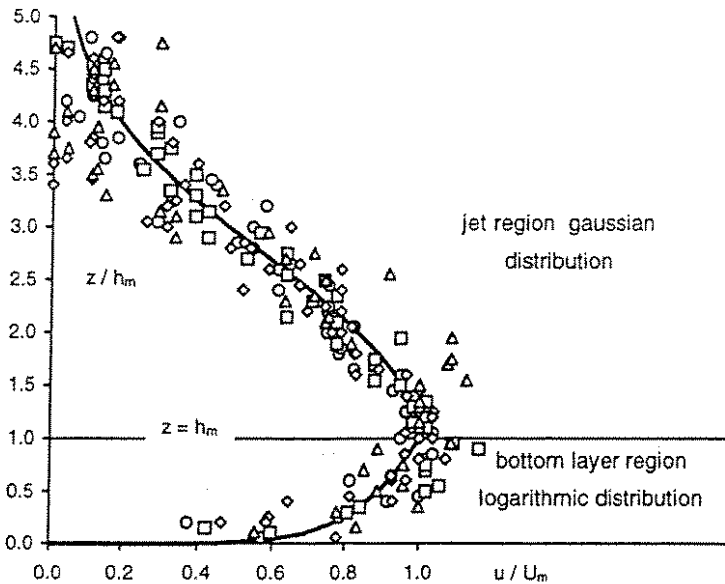

This surface fits well to the position of the interface between the turbidity current and the surrounding water. The velocity vectors are given on a fine grid in a plane parallel to the bottom. This plane is situated at 12 mm from the bottom, the same level as the one where the transducers were installed.

Figure 3:

Measured velocity values compared to theoretical vertical velocity distribution. Values from run n°2, 80 ms between two succeeding measurements

Figure 4:

Computed and measured 2D-flow field 12 mm from the flume bottom and limits of the spreading turbidity current a) 5 and b) 10 s after the opening of the gate; numerical simulation: black velocity vectors, turbidity current as a grey surface; physical model: white velocity vectors, limits of the turbidity current as a bold line.

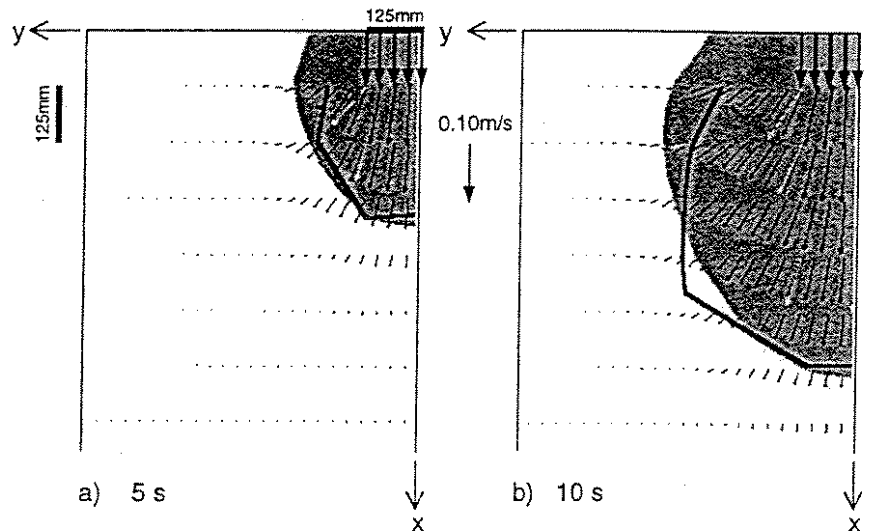

## 5. Conclusions

Good experience with the ultrasonic echography for flow measurement in the laboratory has been acquired. The characteristics of the UVP instrument make it well adapted to operate in physical scale models with turbidity currents. The small ultrasonic transducers allow easy handling and undisturbed flow monitoring. It is possible to capture precise velocity profiles in very short a time.

Computer simulation has been used to predict the advancing 3D-turbidity current in the laboratory and validated with experimental results. Based on the numerical simulation, not only general conclusions can be drawn, but also the precise behaviour of turbidity currents can be predicted.

## References

- Boillat J.-L., De Cesare G. (1994). "Dichteströmungen im Bereich des Grundablasses des Stausees Luzzone – Modellversuche", *Proceedings of the Symposium "Betrieb, Erhaltung und Erneuerung von Talsperren und Hochdruckanlagen"*, pp. 183-192, Graz, Austria.
- De Cesare G. (1998). "Alluvionnement des retenues par courants de turbidité", *PhD Thesis N° 1820 and communication du Laboratoire de constructions hydrauliques - LCH N° 7*, Lausanne, EPFL, Switzerland.
- Fan J., Morris G. L. (1992). "Reservoir Sedimentation. II: Reservoir Desiltation and Long-Term Storage Capacity", *ASCE, Journal of Hydraulic Engineering*, Vol. 118, No. 3.
- Graf W. H. (1984). "Storage losses in reservoirs", *International Water Power & Dam Construction*, Vol. 36, N° 4.
- Rambaud J., Khalanski M. et al. (1988). "Expérience acquise dans les vidanges de retenues par Electricité de France et la Compagnie Nationale du Rhône", *Proceedings of XVIe congrès ICOLD*, Q.60-R.30, San Francisco.
- Schleiss A., Feuz B., Aemmer M., Zünd B. (1996). "Verlandungsprobleme im Stausee Mauvoisin. Ausmass, Auswirkungen und mögliche Massnahmen", *Proceedings of Internationales Symposium «Verlandung von Stauseen und Stauhaltungen, Sedimentprobleme in Leitungen und Kanälen»*, *Mitteilungen der VAW* Nr. 142, Teil 1, pp. 37-58, Zürich, Switzerland.